

**描述 / Descriptions**

SOT-363 塑封封装 NPN+NPN 数字三极管。

Double silicon NPN and NPN transistor in a SOT-363 Plastic Package

**特征 / Features**

内装偏置电阻，简化线路设计，减少元件和制造流程，符合 AEC-Q101 标准高可靠性要求，无卤产品。

With built-in bias resistors, simplify circuit design, reduce a quantity of parts and manufacturing process, Qualified to AEC-Q101 Standards for High Reliability, HF Product.

**用途 / Applications**

用于开关、界面电路以及驱动电路中，满足汽车应用的严格要求。

Switching applications, interface circuit and driver circuit applications, Meet the stringent requirements of automotive applications.

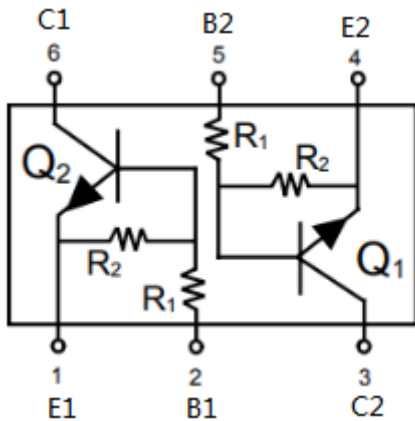
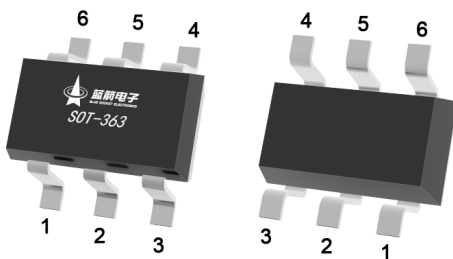
**内部等效电路 / Equivalent Circuit****引脚排列 / Pinning**

PIN 1、4 : Emitter

PIN 2、5 : Base

PIN 3、6 : Collector

**放大及印章代码 / hFE Classifications & Marking**

Marking	Q211
---------	------

**单个三极管极限参数 / Absolute Maximum Ratings(Each Transistor, Ta=25°C)**

参数 Parameter	符号 Symbol	数值 Rating	单位 Unit
Output Voltage	$V_{CC}$	50	V
Input Voltage	$V_{IN}$	40	V
		-10	V
Output Current	$I_{CM}$	100	mA
	$I_O$	50	mA
Collector Dissipation	$P_C$	200	mW
Junction Temperature	$T_j$	150	°C
Storage Temperature Range	$T_{stg}$	-55~150	°C

**单个三极管电性能参数 / Electrical Characteristics((Each Transistor, Ta=25°C)**

参数 Parameter	符号 Symbol	测试条件 Test Conditions	最小值 Min	典型值 Typ	最大值 Max	单位 Unit
Input Voltage	$V_{I(off)}$	$V_{CC}=5.0V$ $I_O=100\mu A$			0.5	V
Input Voltage	$V_{I(on)}$	$V_O=0.3V$ $I_O=10mA$	3			V
Output Voltage	$V_{O(on)}$	$I_O=10mA$ $I_I=0.5mA$			0.3	V
Input Current	$I_I$	$V_I=5.0V$			0.88	mA
Output Cut-off Current	$I_{O(off)}$	$V_{CC}=50V$ $V_I=0V$			0.5	$\mu A$
DC Current Gain	$G_I$	$V_O=5.0V$ $I_O=5.0mA$	30			
Transition Frequency	$f_T$	$V_{CE}=10V$ $I_C=5.0mA$ $f=100MHz$		250		MHz
Resistance1	$R_1$		7	10	13	K $\Omega$
Resistance Ratio	$R_2/R_1$		0.8	1	1.2	

电参数曲线图 / Electrical Characteristic Curve

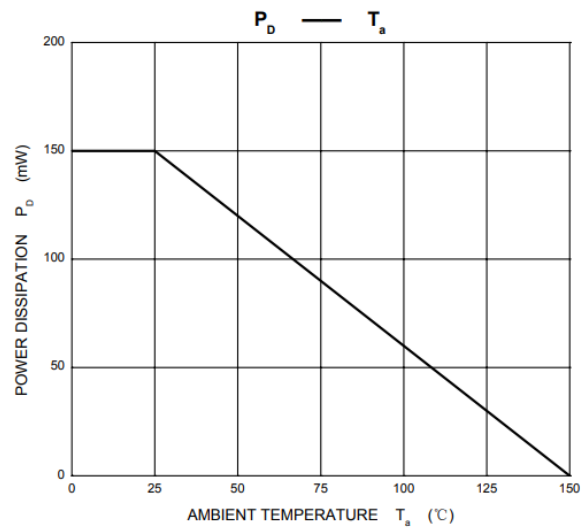
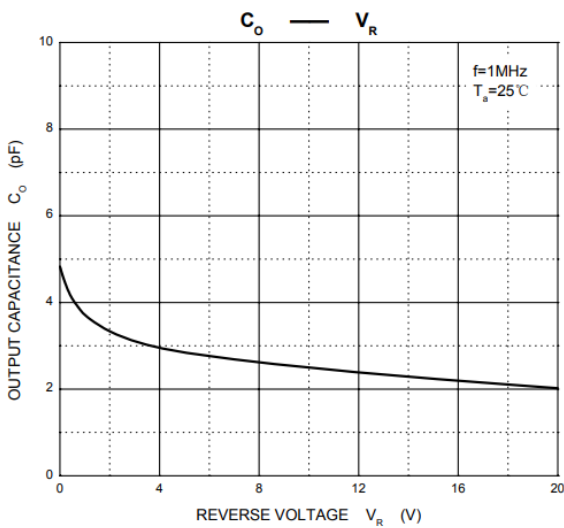
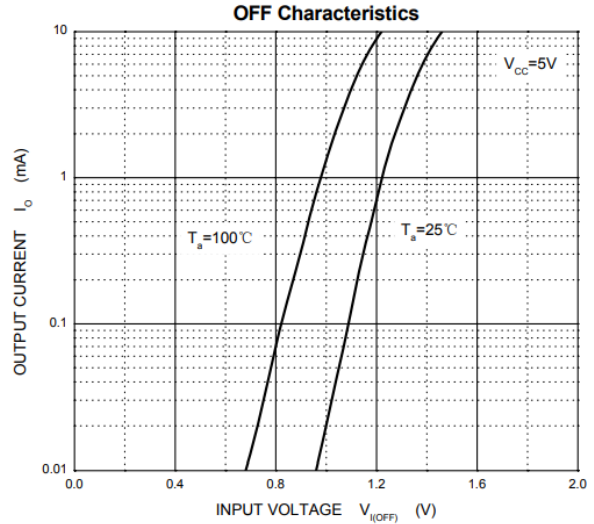
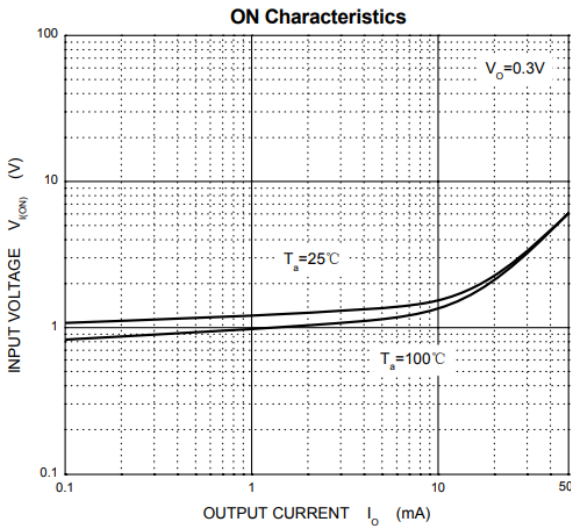
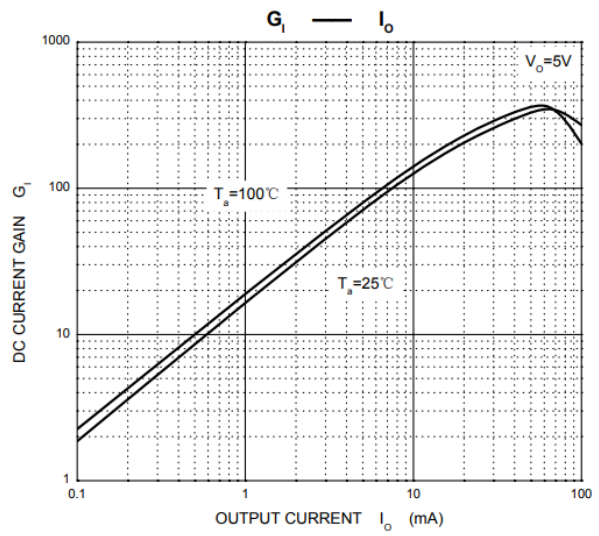
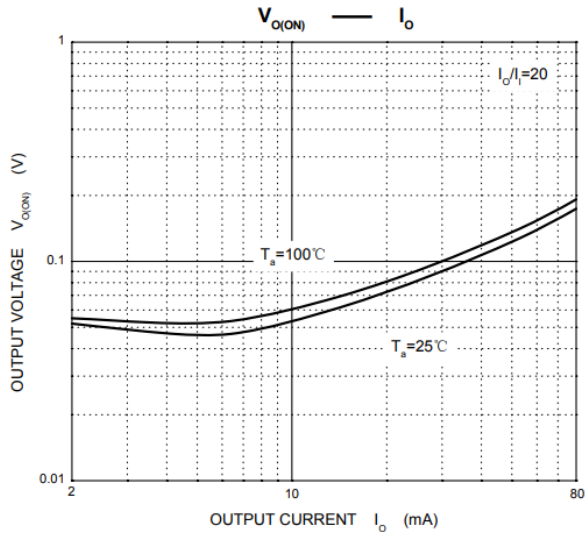

外形尺寸图 / Package Dimensions

SOT-363-6L

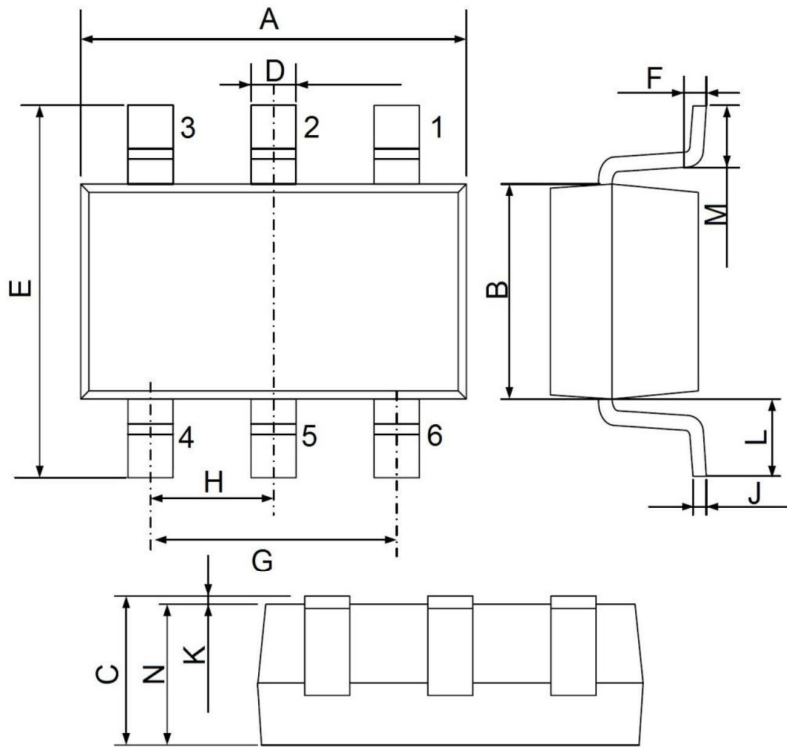

UNIT: mm

DIM	MIN	MAX
A	2.00	2.20
B	1.15	1.35
C	0.90	1.10
D	0.15	0.35
E	1.95	2.25
F	0.20 Typ.	
G	1.20	1.40
H	0.65 Typ.	
J	0.08	0.15
K	0.00	0.10
L	0.525 Ref.	
M	0.26	0.46
N	0.90	1.10

印章说明 / Marking Instructions

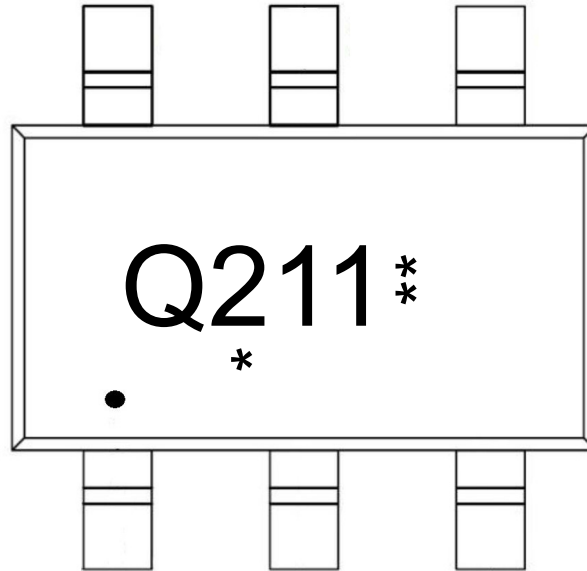

说明：

- ：为“1”脚
- Q：为汽车无卤产品标识
- 211：为型号代码
- \*\*\*：为生产批号代码，随生产批号变化

Note:

- ：“1” Pin
- Q: Automobile halogen-free product Code
- 211: Product Type Code
- \*\*\*: Lot No. Code, code change with Lot No

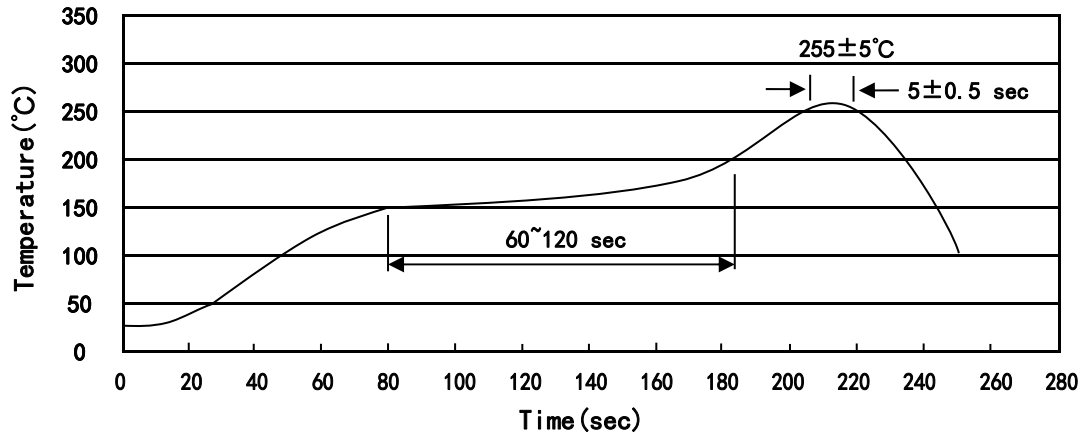
**回流焊温度曲线图(无铅) / Temperature Profile for IR Reflow Soldering(Pb-Free)**

说明：

- 1、预热温度 150~200°C，时间 60~120sec;
- 2、峰值温度 255±5°C，时间持续为 5±0.5sec;
- 3、焊接制程冷却速度为 2~10°C/sec.

Note:

- 1.Preheating:150~200°C, Time:60~120sec.
- 2.Peak Temp.:255±5°C, Duration:5±0.5sec.
3. Cooling Speed: 2~10°C/sec.

**耐焊接热试验条件 / Resistance to Soldering Heat Test Conditions**

温度：260±5°C

时间：10±1 sec.

Temp.:260±5°C

Time:10±1 sec

**包装规格 / Packaging SPEC.**

卷盘包装 / REEL

Package Type 封装形式	Units 包装数量					Dimension 包装尺寸 (unit: mm <sup>3</sup> )		
	Units/Reel 只/卷盘	Reels/Inner Box 卷盘/盒	Units/Inner Box 只/盒	Inner Boxes/Outer Box 盒/箱	Units/Outer Box 只/箱	Reel	Inner Box 盒	Outer Box 箱
SOT-363	3,000	10	30,000	6	180000	7" ×8	180×120×180	390×385×205

**使用说明 / Notices**